

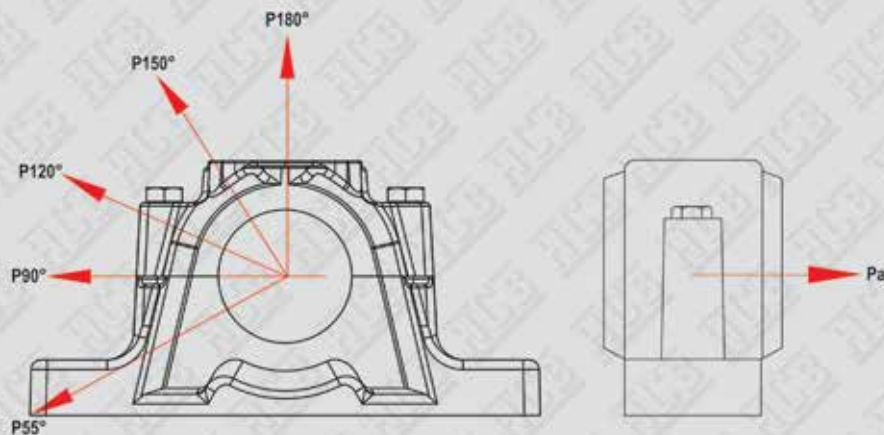

FSNH 500-600





Housing	Breaking loads						
Size	P _{0°}	P _{55°}	P _{90°}	P _{120°}	P _{150°}	P _{180°}	P _a
-	kN	kN	kN	kN	kN	kN	kN
FSNH 505	100	155	95	70	60	80	52
FSNH 506-605	130	170	100	80	65	85	55
FSNH 507-606	140	190	115	85	80	95	60
FSNH 508-607	150	215	130	95	85	110	70
FSNH 509	160	230	140	100	90	115	75
FSNH 510-608	170	265	155	120	110	130	85
FSNH 511-609	190	275	170	125	115	140	90
FSNH 512-610	210	300	180	130	120	150	100
FSNH 513-611	270	340	205	150	130	170	110
FSNH 515-612	290	410	250	185	160	205	135
FSNH 516-613	350	430	260	190	175	215	140
FSNH 517	370	480	290	205	190	240	155
FSNH 518-615	430	550	340	250	215	275	180
FSNH 519-616	450	580	350	260	230	290	190
FSNH 520-617	470	620	370	280	250	310	200
FSNH 522-619	600	680	410	310	275	340	220
FSNH 524-620	800	790	470	350	320	400	260
FSNH 526	900	900	540	410	360	450	295
FSNH 528	1000	1 050	630	470	430	530	345
FSNH 530	1100	1 200	730	540	480	600	390
FSNH 532	1300	1 450	860	640	570	720	470



FSNH 500-600

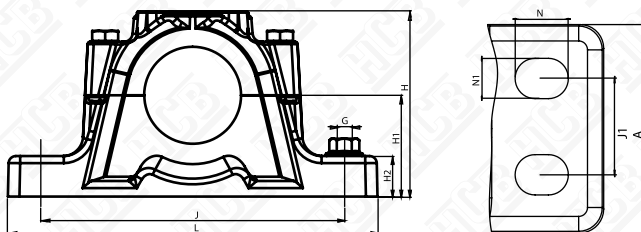

SHAFT	HOUSING	HOUSING WITHOUT SEALS	BEARING	LOCATING RING	END COVER	SEALS
Da						
50	FSNH 511	SNH 511-609	1211 K	2 frb 11.5/100	ASNH 511	TSN 511 G
			2211 K	2 frb 9.5/100		TSN 511 A
			22211 K	2 frb 9.5/100		TSN 511 C
			-	-		TSN 511 S
	FSNH 611	SNH 513-611	1311 K	2 frb 11/120	ASNH 611	TSN 611 G
			2311 K	2 frb 4/120		TSN 611 A
			21311 K	2 frb 11/120		TSN 611 C
			22311 K	2 frb 4/120		TSN 611 S
55	FSNH 512	SNH 512-610	1212 K	2 frb 13/110	ASNH 512	TSN 512 G
			2212 K	2 frb 10/110		TSN 512 A
			22212 K	2 frb 10/110		TSN 512 C
			-	-		TSN 512 S
	FSNH 612	SNH 515-612	1312 K	2 frb 12.5/130	ASNH 612	TSN 612 G
			2312 K	2 frb 5/130		TSN 612 A
			21312 K	2 frb 12.5/130		TSN 612 C
			22312 K	2 frb 5/130		TSN 612 S
60	FSNH 513	SNH 513-611	1213 K	2 frb 14/120	ASNH 513	TSN 513 G
			2213 K	2 frb 10/120		TSN 513 A
			22213 K	2 frb 10/120		TSN 513 C
			-	-		TSN 513 S
	FSNH 613	SNH 516-613	1313 K	2 frb 12.5/140	ASNH 613	TSN 613 G
			2313 K	2 frb 5/140		TSN 613 A
			21313 K	2 frb 12.5/140		TSN 613 C
			22313 K	2 frb 5/140		TSN 613 S
65	FSNH 515	SNH 515-612	1215 K	2 frb 15.5/130	ASNH 515	TSN 515 G
			2215 K	2 frb 12.5/130		TSN 515 A
			22215 K	2 frb 12.5/130		TSN 515 C
			-	-		TSN 515 S
	FSNH 615	SNH 518-615	1315 K	2 frb 14/160	ASNH 615	TSN 615 G
			2315 K	2 frb 5/160		TSN 615 A
			21315 K	2 frb 14/160		TSN 615 C
			22315 K	2 frb 5/160		TSN 615 S

FSNH 500-600

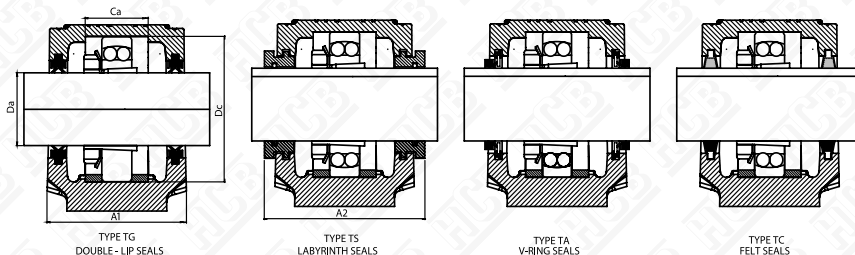

HOUSING	DIMENSIONS														
	Dc	C _a	L	J	J ₁	H	H ₁	H ₂	A	A ₁	A ₂	N	N ₁	G	Kg
FSNH 511	100	44	255	210	35	127	70	28	70	95	107	20	15	12	5,3
FSNH 611	120	51	275	230	40	148	80	30	80	110	122	20	15	12	7,4
FSNH 512	110	48	255	210	35	133	70	30	70	105	117	20	15	12	5,7
FSNH 612	130	56	280	230	40	154	80	30	80	115	127	20	15	12	8,2
FSNH 513	120	51	275	230	40	148	80	30	80	110	122	20	15	12	7,4
FSNH 613	140	58	315	260	50	175	95	32	90	120	138	24	18	16	10,1
FSNH 515	130	56	280	230	40	154	80	30	80	115	127	20	15	12	8,2
FSNH 615	160	65	345	290	50	193	100	35	100	140	158	24	18	16	14,7



FSNH 500-600

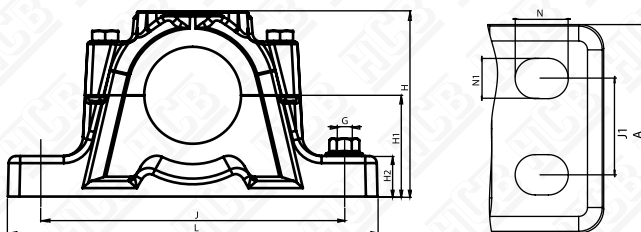

SHAFT	HOUSING	HOUSING WITHOUT SEALS	BEARING	LOCATING RING	END COVER	SEALS
Da						
70	FSNH 516	SNH 516-613	1216 K	2 frb 16/140	ASNH 516	TSN 516 G
			2216 K	2 frb 12.5/140		TSN 516 A
			22216 K	2 frb 12.5/140		TSN 516 C
			-	-		TSN 516 S
	FSNH 616	SNH 519-616	1316 K	2 frb 14.5/170	ASNH 616	TSN 616 G
			2316 K	2 frb 5/170		TSN 616 A
			21316 K	2 frb 14.5/170		TSN 616 C
			22316 K	2 frb 5/170		TSN 616 S
75	FSNH 517	SNH 517	1217 K	2 frb 16.5/150	ASNH 517	TSN 517 G
			2217 K	2 frb 12.5/150		TSN 517 A
			22217 K	2 frb 12.5/150		TSN 517 C
			-	-		TSN 517 S
	FSNH 617	SNH 520-617	1317 K	2 frb 14.5/180	ASNH 617	TSN 617 G
			2317 K	2 frb 5/180		TSN 617 A
			21317 K	2 frb 14.5/180		TSN 617 C
			22317 K	2 frb 5/180		TSN 617 S
80	FSNH 518	SNH 518-615	1218 K	2 frb 17.5/160	ASNH 518	TSN 518 G
			2218 K	2 frb 12.5/160		TSN 518 A
			22218 K	2 frb 12.5/160		TSN 518 C
			-	-		TSN 518 S
	FSNH 618	SNH 618	1318 K	2 frb 15.5/190	ASNH 618	TSN 618 G
			2318 K	2 frb 5/190		TSN 618 A
			21318 K	2 frb 15.5/190		TSN 618 C
			22318 K	2 frb 5/190		TSN 618 S
85	FSNH 519	SNH 519-616	1219 K	2 frb 18/170	ASNH 519	TSN 519 G
			2219 K	2 frb 12.5/170		TSN 519 A
			22219 K	2 frb 12.5/170		TSN 519 C
			-	-		TSN 519 S
	FSNH 619	SNH 522-619	1319 K	2 frb 17.5/200	ASNH 619	TSN 619 G
			2319 K	2 frb 6.5/200		TSN 619 A
			21319 K	2 frb 17.5/200		TSN 619 C
			22319 K	2 frb 6.5/200		TSN 619 S

FSNH 500-600

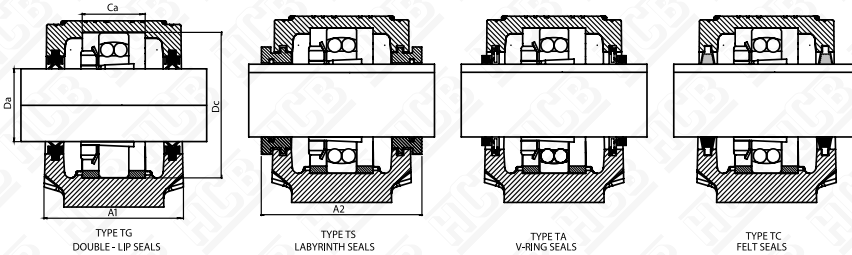

HOUSING	DIMENSIONS														
	Dc	C _a	L	J	J ₁	H	H ₁	H ₂	A	A ₁	A ₂	N	N ₁	G	Kg
FSNH 516	140	58	315	260	50	175	95	32	90	120	138	24	18	16	10,6
FSNH 616	170	68	345	290	50	210	112	35	100	145	163	24	18	16	17
FSNH 517	150	61	320	260	50	183	95	32	90	125	143	24	18	16	11,3
FSNH 617	180	70	380	320	60	215	112	40	110	160	178	24	18	16	20,4
FSNH 518	160	65	345	290	50	193	100	35	100	140	158	24	18	16	14,7
FSNH 618	190	74	380	320	60	229	112	40	110	155	128	24	18	16	16,5
FSNH 519	170	68	345	290	50	210	112	35	100	145	163	24	18	16	17
FSNH 619	200	80	410	350	70	239	125	45	120	175	191	24	18	16	25,8



FSNH 500-600

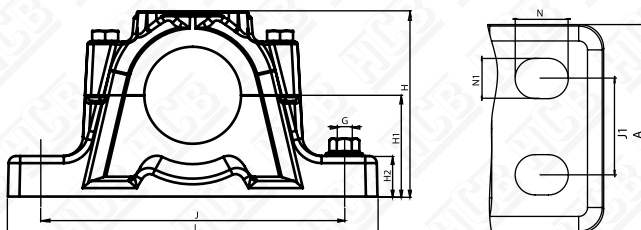

SHAFT	HOUSING	HOUSING WITHOUT SEALS	BEARING	LOCATING RING	END COVER	SEALS
Da						
90	FSNH 520	SNH 520-617	1220 K	2 frb 18/180	ASNH 520	TSN 520 G
			2220 K	2 frb 12/180		TSN 520 A
			22220 K	2 frb 12/180		TSN 520 C
			23220 K	2 frb 4.85/180		TSN 520 S
	FSNH 620	SNH 524-620	1320 K	2 frb 19.5/215	ASNH 620	TSN 620 G
			2320 K	2 frb 6.5/215		TSN 620 A
			21320 K	2 frb 19.5/215		TSN 620 C
			22320 K	2 frb 6.5/215		TSN 620 S
100	FSNH 522	SNH 522-619	1222 K	2 frb 21/200	ASNH 522	TSN 522 G
			2222 K	2 frb 13.5/200		TSN 522 A
			22222 K	2 frb 13.5/200		TSN 522 C
			23222 K	2 frb 5.1/200		TSN 522 S
110	FSNH 524	SNH 524-620	1224 K	2 frb 22/215	ASNH 524	TSN 524 G
			22224 K	2 frb 14/215		TSN 524 A
			23224 K	2 frb 5/215		TSN 524 C
			-	-		TSN 524 S
			-	-		-
115	FSNH 526	SNH 526-226	22226 K	2 frb 13/230	ASNH 526	TSN 526 G
			23226 K	2 frb 5/230		TSN 526 A
			-	-		TSN 526 C
			-	-		TSN 526 S
			-	-		-
125	FSNH 528	SNH 528-228	22228 K	2 frb 15/250	ASNH 528	TSN 528 G
			23228 K	2 frb 5/250		TSN 528 A
			-	-		TSN 528 C
			-	-		TSN 528 S
			-	-		-
135	FSNH 530	SNH 530-230	22230 K	2 frb 16.5/270	ASNH 530	TSN 530 G
			23230 K	2 frb 5/270		TSN 530 A
			-	-		TSN 530 C
			-	-		TSN 530 S
			-	-		-
140	FSNH 532	SNH 532-232	22232 K	2 frb 17/290	ASNH 532	TSN 532 G
			23232 K	2 frb 5/290		TSN 532 A
			-	-		TSN 532 C
			-	-		TSN 532 S
			-	-		-

FSNH 500-600

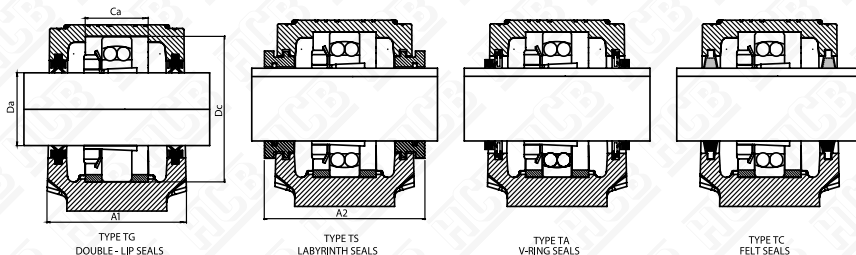

HOUSING	DIMENSIONS														
	Dc	C _a	L	J	J ₁	H	H ₁	H ₂	A	A ₁	A ₂	N	N ₁	G	Kg
FSNH 520	180	70	380	320	60	215	112	40	110	160	178	24	18	16	20,4
FSNH 620	215	86	410	350	70	271	140	45	120	185	199	24	18	16	32,6
FSNH 522	200	80	410	350	70	239	125	45	120	175	191	24	18	16	25,8
FSNH 524	215	86	410	350	70	271	140	45	120	185	199	24	18	16	32,6
FSNH 526	230	90	445	380	70	290	150	50	130	190	208	28	22	20	40,2
FSNH 528	250	98	500	420	80	302	150	50	150	205	233	32	26	24	50,8
FSNH 530	270	106	530	450	90	323	160	60	160	220	241	32	26	24	59,7
FSNH 532	290	114	550	470	90	344	170	60	160	235	254	32	26	24	69